

























# Electric Components ECL3000/4000

- D** Elektroschema mit Sicherheitshinweisen
- EN** Electrical schema and safety instructions
- FR** Schéma électrique et consignes de sécurité
- IT** Schema elettrico e istruzioni di sicurezza
- NL** Elektrisch schema en veiligheidsinstructies
- CS** Elektrická schéma a bezpečnostní pokyny
- PL** Schemat elektryczny oraz wskazówki dotyczące bezpieczeństwa
- SE** Elschema med säkerhetsanvisningar

	1	2	3	4	5	6	7	8		
A	 <h3>D Sicherheitshinweise</h3> <p>Vor dem Anschluss der Anlage sind unbedingt die nachfolgenden Sicherheitshinweise zu lesen und zu beachten. Eine Nichtbeachtung kann zu Gefahren für Personen oder Beschädigung an der Anlage führen. Sofort nach dem Auspacken der Einheit ist diese auf Beschädigungen zu prüfen. Wenn anzunehmen ist, dass ein gefahrloser Betrieb nicht gewährleistet werden kann, so ist diese unverzüglich außer Betrieb zu nehmen und gegen unbeabsichtigten Betrieb zu sichern. Die bauseitige Elektroinstallation ist von konzessionierten Elektroinstallateuren vornehmen zu lassen. Elektrische Anschlüsse so ausführen, dass sie jederzeit zugänglich und abschaltbar bleiben Verdrahtungsarbeiten im spannungslosen Zustand ausführen. Die angegebene Schutzart ist nur bei einem unversehrten und vollständigen Gehäuse gegeben Betrieb nur mit einem vorgeschalteten FI-Schutzschalter max. 30mA Typ A. Die örtlichen Bestimmungen und Schutzmassnahmen sind zu beachten. Installations- und Montageanleitungen befolgen. Allfällige Entsorgung gemäss den geltenden gesetzlichen Bestimmungen.</p>			 <h3>EN safety instructions</h3> <p>The following safety instructions must be read and observed before connecting the system. Failure to do so may result in danger to persons or damage to the system. Check the unit for any damage as soon as it is unpacked If it is ascertained that safe operation cannot be guaranteed it must be taken out of service immediately and secured from unintentional operation The electric installation on site must be undertaken by authorised electricians Make the electric connections in such a way that they are always accessible and can be switched off Wiring work must be performed with the power disconnected The stipulated protection class is only featured for undamaged and complete housing Operation only with a downstream ground fault circuit interrupter, max. 30mA Type A. Local regulations and protective measures must be observed Follow the installation and assembly instructions. Any disposal must be performed according to the applicable legal provisions.</p>						
B										
C										
D	 <h3>FR consignes de sécurité</h3> <p>Les consignes de sécurité suivantes doivent impérativement être lues et prises en compte avant le raccordement de l'installation. Leur non-respect peut compromettre la sécurité des personnes ou l'état de l'installation. Il convient de vérifier l'état dès le déballage de l'unité. Si on estime que le fonctionnement sûr n'est pas garanti, l'appareil doit être mis hors service immédiatement et protégé contre toute mise en service par inadvertance. L'installation électrique sur le site doit être confiée à des installateurs-électriciens agréés. Réaliser les raccordements électriques de sorte à ce qu'ils restent accessibles et puissent être coupés à tout moment Réaliser les travaux de câblage hors tension La classe de protection ne vaut que pour un boîtier intact et entier Fonctionnement uniquement avec un disjoncteur différentiel en amont de max. 30 mA type A. Les dispositions locales et les mesures de protection doivent être respectées. Respecter les instructions d'installation et de montage. Elimination éventuelle selon les dispositions légales en vigueur.</p>			 <h3>IT istruzioni di sicurezza</h3> <p>Prima di collegare l'impianto, leggere attentamente le seguenti indicazioni di sicurezza e rispettarle. Il mancato rispetto potrebbe mettere in pericolo le persone o provocare danni alle cose. Subito dopo aver tolto l'unità dalla confezione è necessario verificare l'assenza di eventuali danni Se si ha il sospetto di non poter garantire l'assenza di pericolo durante il funzionamento, è necessario disattivare immediatamente L'installazione elettrica deve essere eseguita da elettricisti autorizzati. Eseguire i collegamenti elettrici in maniera che questi rimangano sempre accessibili e che possano essere sempre scollegati Eseguire i lavori di cablaggio sempre in assenza di tensione Il grado di protezione indicato è valido solo se l'alloggiamento risulta integro e intatto Funzionamento solo con un interruttore differenziale di Tipo A da max. 30 mA pre collegato. È d'obbligo osservare le disposizioni locali e misure protettive. Seguire le istruzioni di installazione e montaggio. Lo smaltimento deve essere conforme alle norme di legge vigenti.</p>						
E										
F										

Index	Datum	Name	Gezeichnet
A	28.02.2020	S.Heer	SH
			Erstelldatum
			28.11.2019



	1	2	3	4	5	6	7	8			
A	 <h3>NL veiligheidsinstructies</h3> <p>Voorafgaand aan de aansluiting van de installatie moeten de onderstaande veiligheidsinstructies beslist worden gelezen en opgevolgd. Het niet-opvolgen van deze instructies kan gevaaren opleveren voor personen of een beschadiging van de installatie tot gevolg hebben.</p> <p>Meteen na het uitpakken van de eenheid moet deze op beschadigingen worden gecontroleerd</p> <p>Als het waarschijnlijk is dat de veilige werking niet kan worden gegarandeerd, moet de verlichting onmiddellijk buiten gebruik worden gesteld en tegen onbedoeld gebruik worden beveiligd.</p> <p>De elektrische installatie ter plaatse dient te worden uitgevoerd door erkende elektromonteurs. Voer elektrische aansluitingen zo uit dat ze op elk gewenst moment toegankelijk blijven en kunnen worden uitgeschakeld</p> <p>De aangegeven beschermingsklasse is alleen gegarandeerd bij een intacte en volledige behuizing</p> <p>Gebruik het apparaat uitsluitend met een voorgeschakelde FI-veiligheidsschakelaar van max. 30 mA type A</p> <p>De plaatselijke voorschriften en beschermende maatregelen moeten in acht worden genomen</p> <p>Volg de installatie- en montagehandleidingen op.</p> <p>Zorg ervoor dat het product wordt verwijderd volgens de geldende wettelijke voorschriften voor afvalverwerking.</p>			 <h3>CZ bezpečnostní</h3> <p>Před zapojením zařízení je bezpodmínečně nutné přečíst si tyto bezpečnostní pokyny a dodržovat je. Při nedodržení pokynů hrozí nebezpečí vážných úrazů nebo úmrtí či poškození zařízení.</p> <p>Hned po vybalení jednotky zkontrolujte, zda není poškozená.</p> <p>Pokud je zjevné, že nelze zajistit bezpečný provoz, je třeba zařízení okamžitě uvést mimo provoz a zajistit proti neúmyslnému spuštění.</p> <p>Elektroinstalační práce na budově musí provádět kvalifikovaný elektrikář.</p> <p>Elektrické spoje musí být kdykoli přístupné a odpojitelné.</p> <p>Elektroinstalační práce neprovádějte pod napětím.</p> <p>Uvedený stupeň krytí je zajištěn pouze v případě, je-li kryt zařízení nepoškozený a kompletní.</p> <p>Provoz je možný jen s předřazeným proudovým chráničem max. 30mA typu A.</p> <p>Je třeba dodržovat předpisy a Ochranná opatření platné v místě provozu zařízení.</p> <p>Dodržujte předepsaný postup instalace a montážní návod.</p> <p>Případný odpad zlikvidujte podle platných zákonných ustanovení.</p>							
B											
C											
D	 <h3>PL Wskazówki dotyczące bezpieczeństwa</h3> <p>Przed podłączeniem urządzenia należy koniecznie zapoznać się z poniższymi wskazówkami bezpieczeństwa, do których należy się kategoriycznie stosować. Niezastosowanie się do wskazówek może prowadzić do zagrożenia dla osób oraz do uszkodzenia urządzenia.</p> <p>Natychmiast po wyjęciu urządzenia z opakowania należy sprawdzić, czy nie jest uszkodzone.</p> <p>Jeżeli istnieje podejrzenie, że nie może być zagwarantowana bezpieczna eksploatacja, należy niezwłocznie wyłączyć urządzenie z eksploatacji i zabezpieczyć przed przypadkowym uruchomieniem.</p> <p>Wykonanie instalacji elektrycznej należy zlecać elektrykowi mającym odpowiednie uprawnienia.</p> <p>Podłączenia elektryczne wykonywać w taki sposób, aby były zawsze dostępne i aby zawsze istniała możliwość ich rozłączenia.</p> <p>Prace przy okablowaniu wykonywać zawsze w stanie beznapięciowym.</p> <p>Podany stopień ochrony jest zapewniony tylko w przypadku nieuszkodzonej i kompletnej obudowy.</p> <p>Eksploatacja wyłącznie z zastosowanym wyłącznikiem ochronnym prądowym maks. 30 mA typ A.</p> <p>Należy przestrzegać obowiązujących lokalnie przepisów i środki ochronne.</p> <p>Stosować się do instrukcji instalacji i montażu.</p> <p>Wszelką utylizację przeprowadzać zgodnie z obowiązującymi przepisami ustawowymi.</p>			 <h3>SE Säkerhetsanvisningar</h3> <p>Innan anläggningen ansluts måste följande säkerhetsanvisningar läsas igenom och observeras. Underlåtenhet att göra detta kan medföra risk för personskador eller skador på anläggningen.</p> <p>Omedelbart efter att enheten packas ur ska den kontrolleras beträffande skador.</p> <p>Om riskfri användning inte kan garanteras ska enheten omedelbart tas ur drift och säkras mot oavsiktlig användning.</p> <p>Elinstallationen på plats ska utföras av kvalificerade elinstallatörer.</p> <p>Placera de elektriska anslutningarna så att de alltid är tillgängliga och frånkopplingsbara</p> <p>Utför dragningsarbetet i spänningslöst tillstånd.</p> <p>Den angivna kapslingsklassen gäller endast vid ett intakt och komplett hölje</p> <p>Använd endast med en förkopplad FI-skyddsavbrytare med max. 30 mA, typ A.</p> <p>Beakta lokala bestämmelser och skyddsåtgärder.</p> <p>Följ installations- och monteringsanvisningarna.</p> <p>Eventuell kassering enligt gällande lagbestämmelser.</p>							
E											
F											

Index	Datum	Name	Gezeichnet
A	28.02.2020	S.Heer	SH
			Ersteldatum
			28.11.2019



1.  =  /  M = 

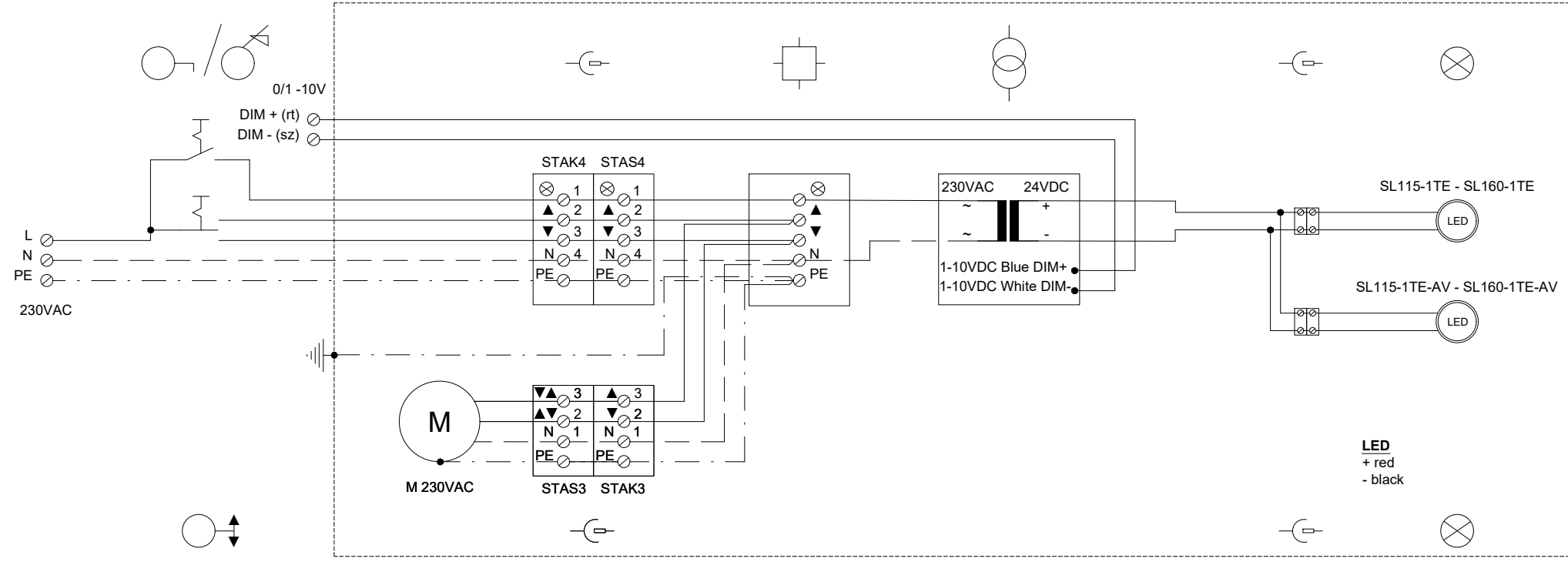
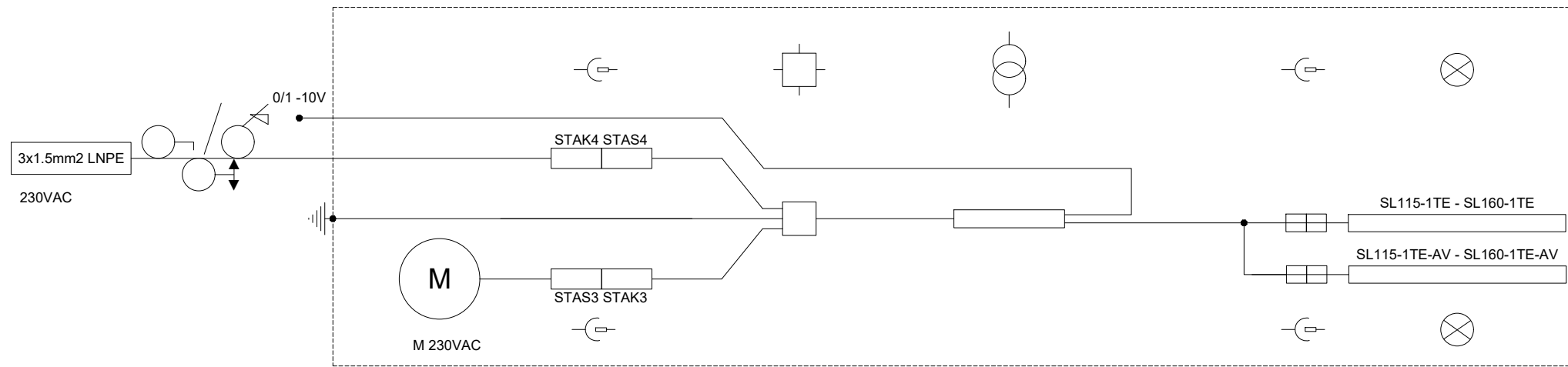

TinLine GmbH

Index	Datum	Name	Gezeichnet
A	28.02.2020	S.Heer	SH
			Erstelldatum
			28.11.2019



ECL4101



Art.Nr. 262195

Blatt 5  
< 4 6 >

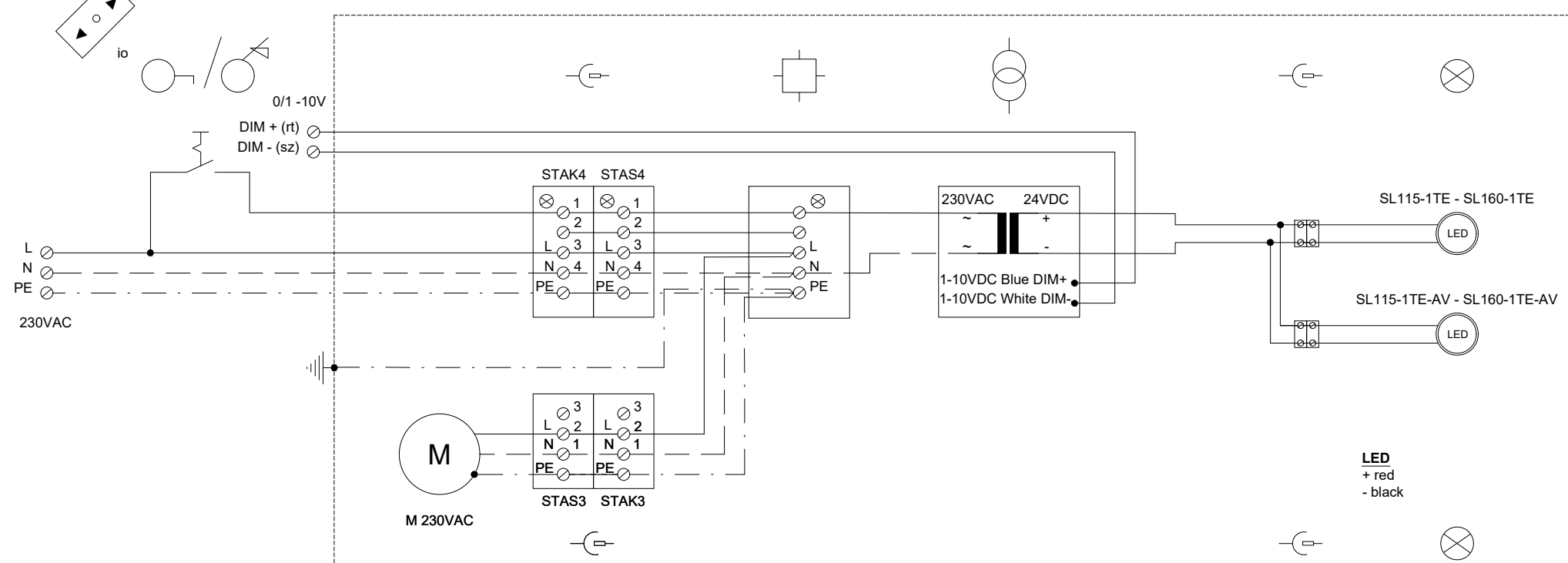
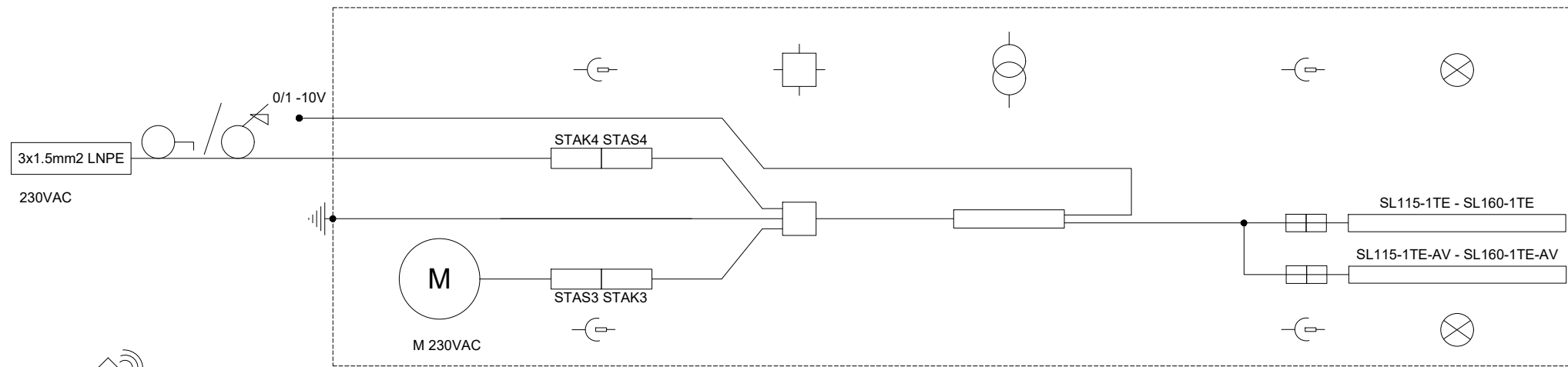
2.  =  M =  io



Index	Datum	Name	Gezeichnet
A	28.02.2020	S.Heer	SH
			Erstelldatum
			28.11.2019

3.  +  =  io

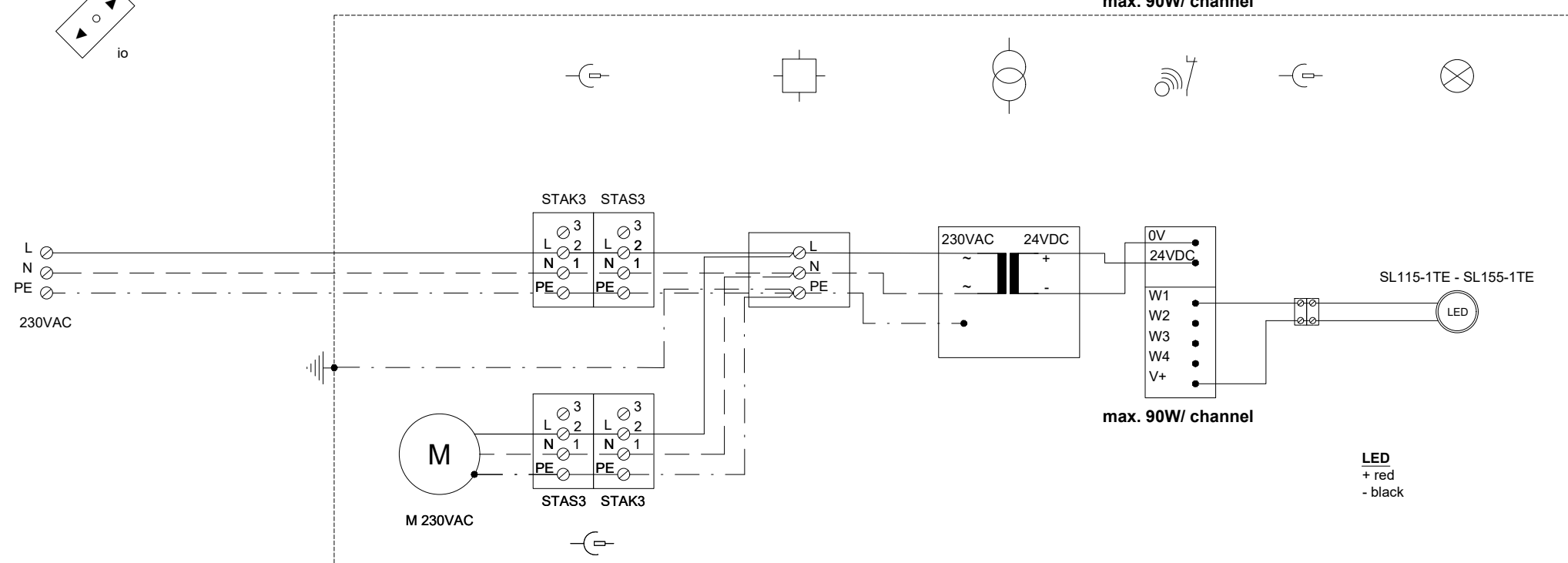
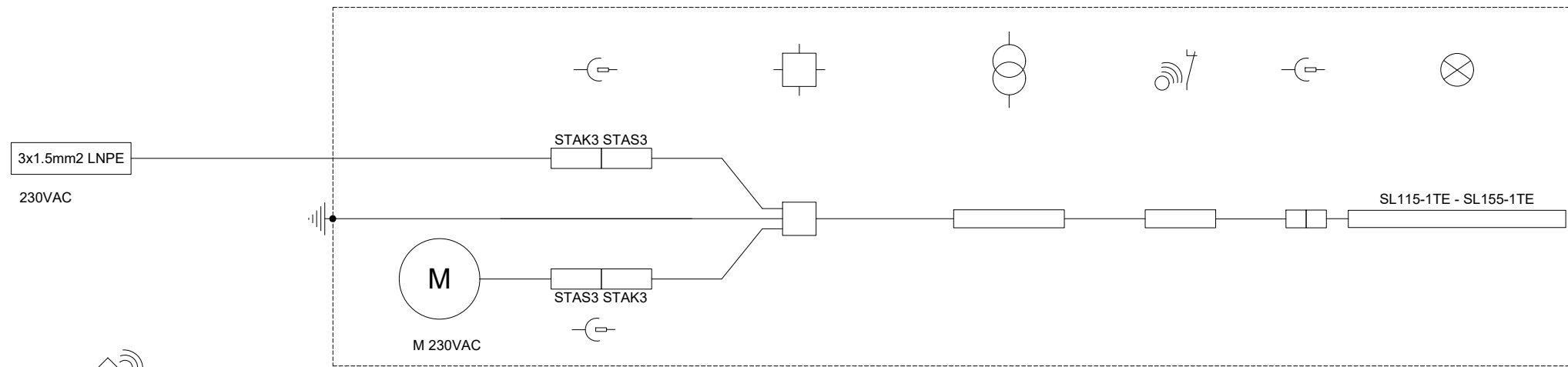

TinLine GmbH



Index	Datum	Name	Gezeichnet
A	28.02.2020	S.Heer	SH
			Erstelldatum
			28.11.2019



ECL3303

Auftrag:  
Schema: Art.Nr. 262195

Blatt 7  
< 6 8 >

4.  +  =  io

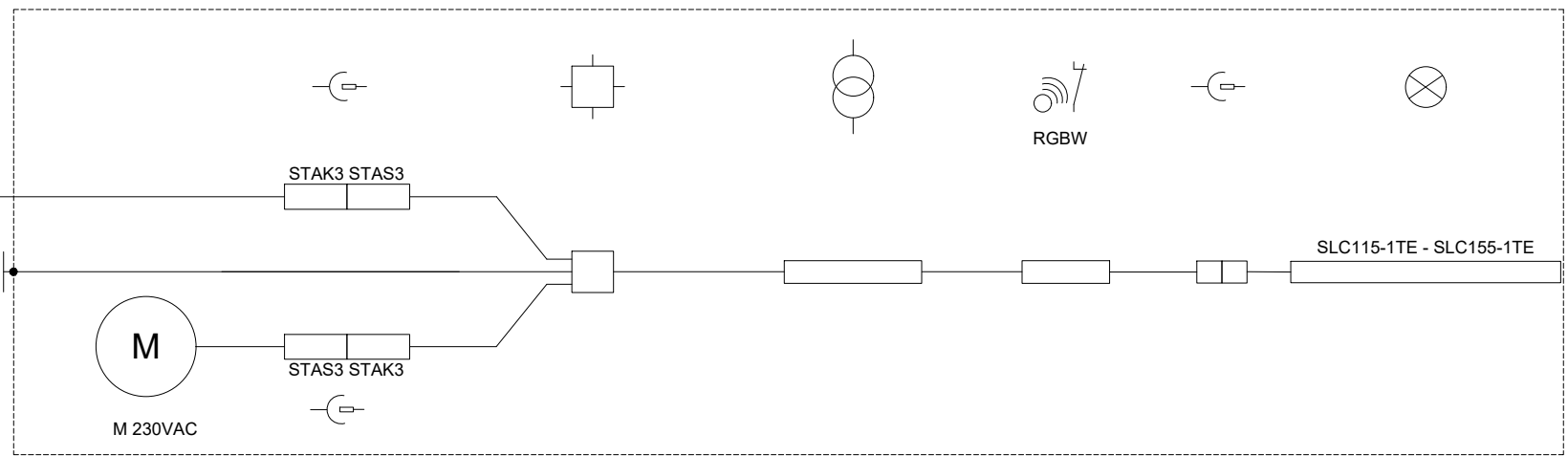

max. 90W/ channel

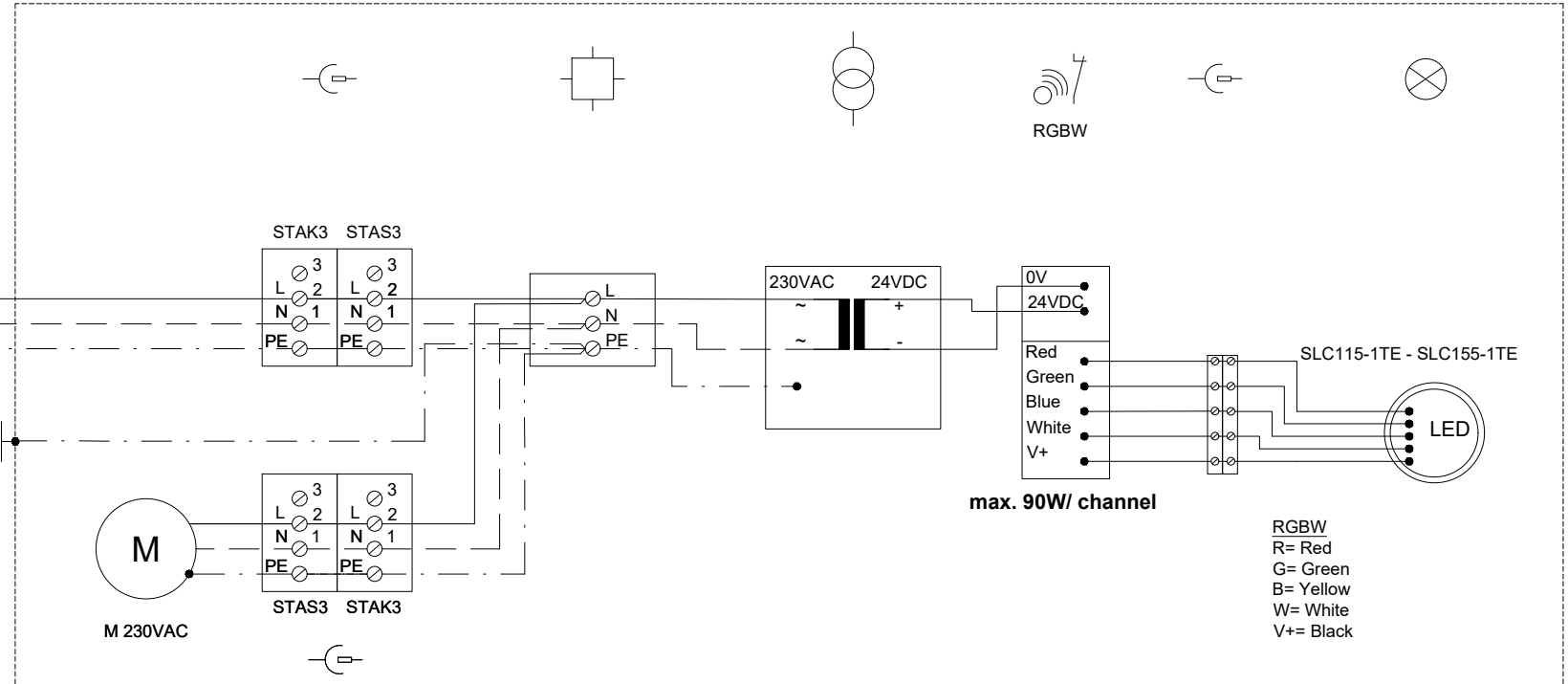

max. 90W/ channel

RGBW  
R= Red  
G= Green  
B= Yellow  
W= White  
V+= Black

TinLine GmbH

Index	Datum	Name	Gezeichnet
A	28.02.2020	S.Heer	SH
			Erstelldatum
			28.11.2019



ECL3305

Auftrag:  
Schema: Art.Nr. 262195

Blatt 8  
< 7 9 >

5. + = io

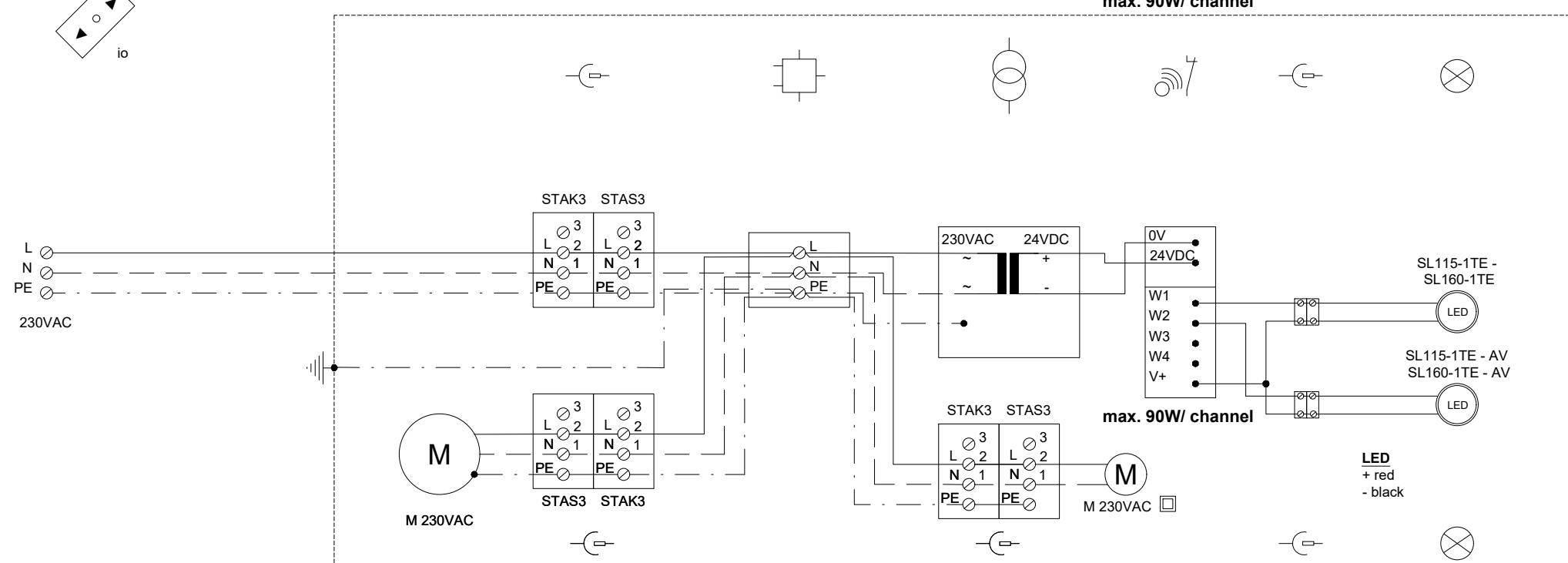
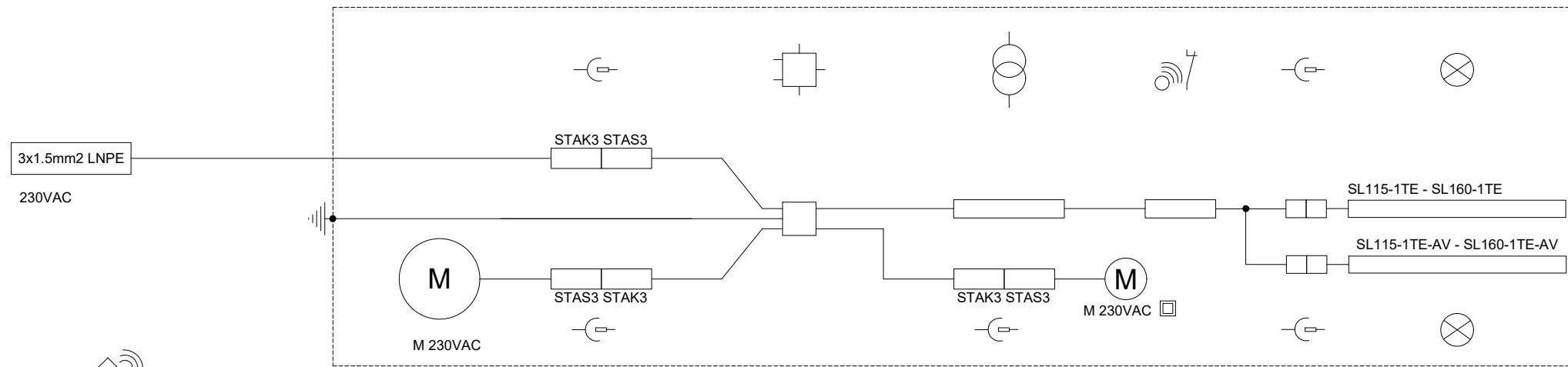

TinLine GmbH

Index	Datum	Name	Gezeichnet
A	28.02.2020	S.Heer	SH
			Erstelldatum
			28.11.2019



ECL4303

Auftrag:  
Schema: Art.Nr. 262195

Blatt 9  
< 8 10 >



6. RGBW + M = io

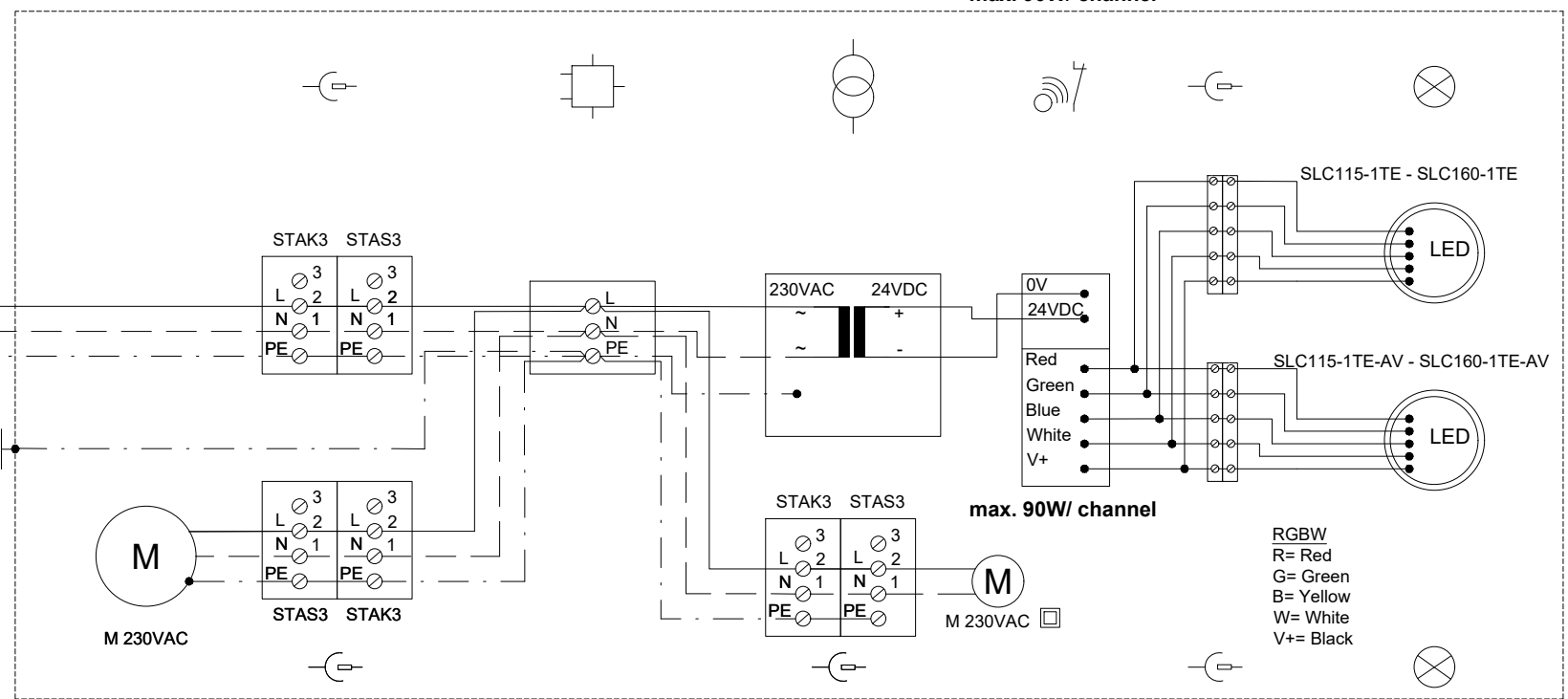
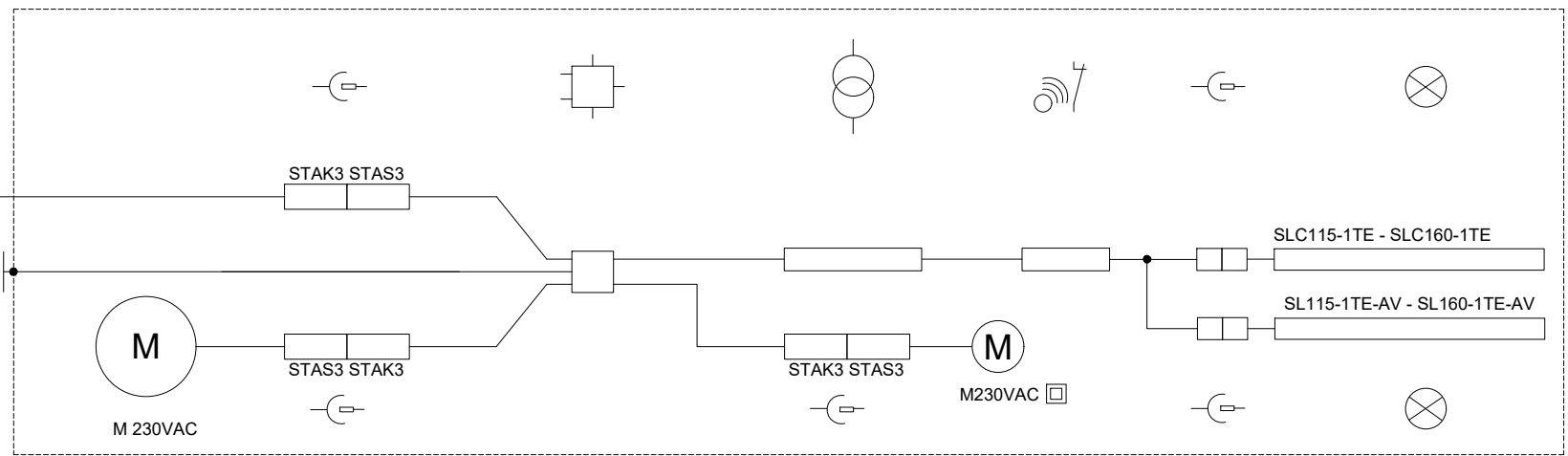

TinLine GmbH

Index	Datum	Name	Gezeichnet
A	28.02.2020	S.Heer	SH
			Erstelldatum
			28.11.2019



ECL4305

Auftrag:  
Schema: Art.Nr. 262195

Blatt 10  
< 9 11 >

7.  $\text{M} = \begin{matrix} \uparrow \\ \text{O} \\ \downarrow \end{matrix} \text{io}$

3x1.5mm<sup>2</sup> LNPE

230VAC

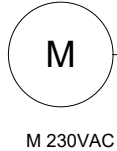

STAK3 STAS3

STAS3 STAK3

STAK3 STAS3

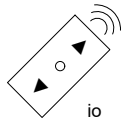

STAK3 STAS3

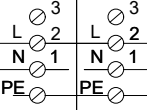

STAK3 STAS3

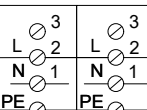
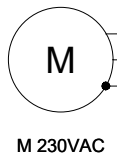
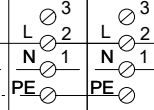

STAS3 STAK3



L  
N  
PE

230VAC

Index	Datum	Name	Gezeichnet
A	28.02.2020	S.Heer	SH
			Erstelldatum
			28.11.2019